

Article number: 20343660M12100KR

Description: E+G levelling foot
GN 343.6-60-M12-100-KR

Measures

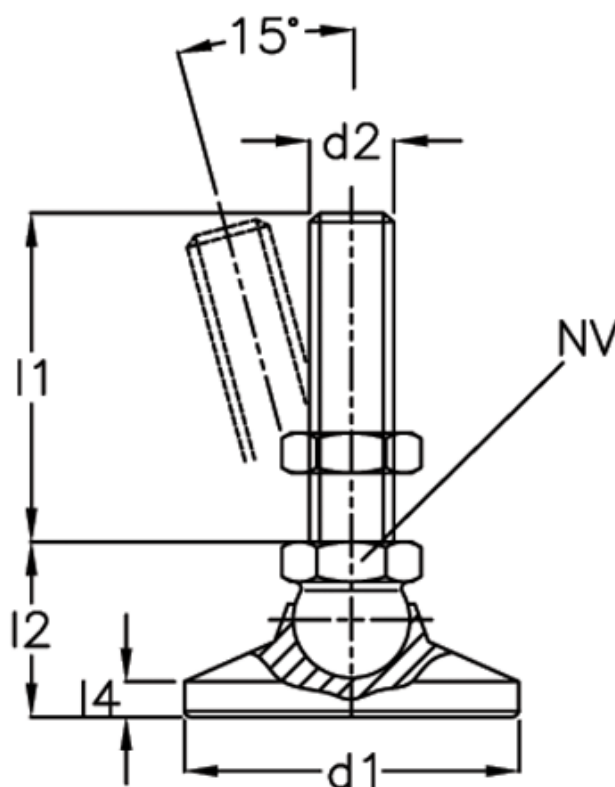

A/F	= 17
d1	= 60
d2	= 12
l1	= 100
l2	= -
l4	= -
Static load (N)	= 30
Weight in (g)	= 474